

Connect & Protect Underground Fiber Optic Network

Model – CYV-3048 Vault Series

CANYON CYV-3048 Series Vault system is SCTE77-Tier22 load capacity, designed for underground network access, especially for fiber optical and electricity industries. Manufactured with innovated composite material, making CYV-3048 Vault Series an ideal solution of strong, light, flexible, time & cost saving comparing to concrete manholes.

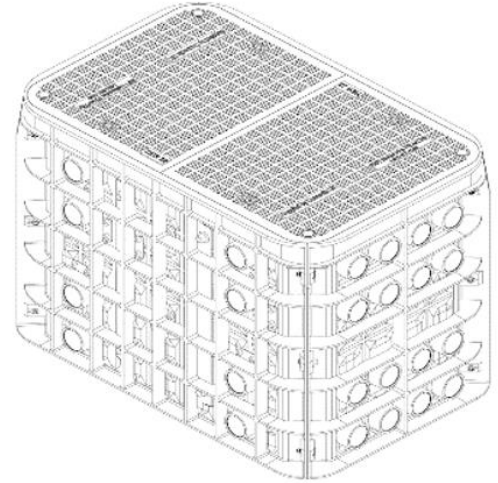

Technical Features

1 Knock-down and delivered with flat package

Low transport cost.
Fast set up on site.
70% time saving compared to concrete.
No heavy truck to lift.

2 Duct Entry Provision

Fast knock-out entry.
Duct reducer and sealing.

3 Fast-Clip connecting kit

No bolt or tool required.
50% time saving.

4 Bottom plate (Optional)

Base provide a clean finish.
Anti-slip and prevent vegetation.

5 Cable & Closure bracket

Provide slack cable storage.
Hold closure.

6 Optional locking system

7 Customer logo
Customized on cover available

8 Ladder (Optional)



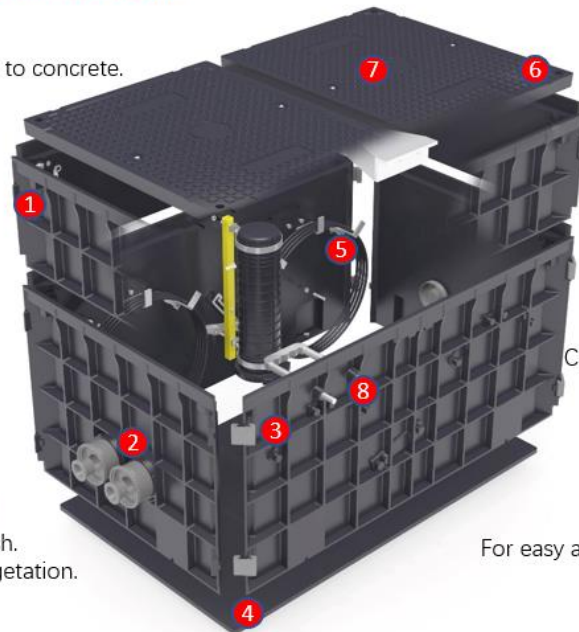

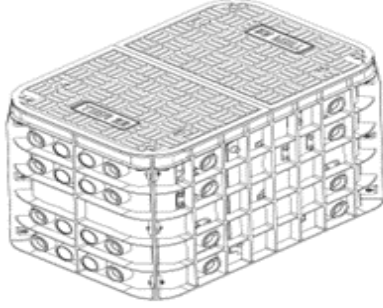

For easy and safe access into manhole









Order & Specification Information:

Vault Model#	CYV-3048
Outlook	
Internal Size (inch) WxLxH	30x48x36
External Size (inch) WxLxH	32x50x36
Weight (lbs)	326.98
Side Wall parts included	
CYVP-2436S	2
CYVP-2436L	2
CYVP-2436C	2

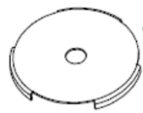
Side Wall Parts	Description	Size (inch)	Weight (lbs)
CYVP-3048S	Short Side Wall for CYV-3048	33x36	34.96
CYVP-3048L	Long Side Wall for CYV-3048	51x36	61.33
CYVP-3048C	Cover for CYV-3048	26x39, 2 Lids	67.2

Assemble Parts	Specifications	QTY	Description	Reference Picture
CYV-ACC-HHSM12100	Hex Head Screw, M12X100mm	4	Fasten lid onto walls	
CYV-ACC-SNUTM12	Square Nut, M12, Customized	4	Buried into walls, work with lid screw	
CYV-ACC-SNC3020	Square Nut Case, 31X20mm	4	Load square nut into walls	
CYV-ACC-FHSM610	Flat Head Screw, Cross pattern, Flat Head	8	Fasten nut case onto walls	
CYV-ACC-HSDM12	HEX Screw Driver for HEX Head M12	1	Fasten and unfasten the screw	
CYV-ACC-BKT822-1	J-Bracket1, Dimension 80x25x25mm, big hole	4	Holding FOSC or loop cable	

CYV-ACC-HHSM820	Hex Head Screw, M8X20mm	8	Fasten J-Bracket onto walls	
CYV-ACC-HHSM860	Hex Head Screw, M8X60mm	12	Fasten 2 walls	
CYV-ACC-NUTM8	M8 Nut	20	For J-Bracket and wall connecting bolt	
CYV-ACC-MC75	Marker Case, Diameter 75mm	1	Holding marker in, at lid back	
CYV-ACC-SHSM1016	Socket Head Screw, M10X16	1	Screw Marker Case at lid back	
CYV-ACC-WasherM10	Washer, 11X20mm (in and out diameter)	21	Fasten on Marker Case, J-Bracket, and Wall connect Bolt	
CYV-ACC-HK30	Hook, S.S 30mm Long	2	Per 2 vault equip 1 pair of hook	

CYV-3048 External Dimension

